

ESPAÑOL: PÁGINA 23
FRANÇAISE : PAGE 43

Instruction manual

Double Insulated Plate Joiner



MODEL
557

To learn more about Porter-Cable
visit our website at:

<http://www.porter-cable.com>

PORTER-CABLE
PROFESSIONAL POWER TOOLS

IMPORTANT

Please make certain that the person who is to use this equipment carefully reads and understands these instructions before starting operations.

The Model and Serial No. plate is located on the main housing of the tool. Record these numbers in the spaces below and retain for future reference.

Model No. _____

Type _____

Serial No. _____

TABLE OF CONTENTS

IMPORTANT SAFETY INSTRUCTIONS	2
SAFETY GUIDELINES	3
GENERAL SAFETY RULES	4
ADDITIONAL SPECIFIC SAFETY RULES	6
CARTON CONTENTS	8
FUNCTIONAL DESCRIPTION	9
ASSEMBLY	9
OPERATION	9
TROUBLESHOOTING	20
MAINTENANCE	20
SERVICE	21
ACCESSORIES	21
WARRANTY	22
ESPAÑOL	23
FRANÇAISE	43
SERVICE CENTER LOCATIONS	back cover

IMPORTANT SAFETY INSTRUCTIONS

▲ WARNING Read and understand all warnings and operating instructions before using any tool or equipment. When using tools or equipment, basic safety precautions should always be followed to reduce the risk of personal injury. Improper operation, maintenance or modification of tools or equipment could result in serious injury and property damage. There are certain applications for which tools and equipment are designed. Porter-Cable strongly recommends that this product NOT be modified and/or used for any application other than for which it was designed.

If you have any questions relative to its application DO NOT use the product until you have written Porter-Cable and we have advised you.

Online contact form at www.porter-cable.com

Postal Mail: Technical Service Manager
Porter-Cable Corporation
4825 Highway 45 North
Jackson, TN 38305

Information regarding the safe and proper operation of this tool is available from the following sources:

Power Tool Institute

1300 Sumner Avenue, Cleveland, OH 44115-2851

www.powertoolinstitute.org

National Safety Council

1121 Spring Lake Drive, Itasca, IL 60143-3201

American National Standards Institute, 25 West 43rd Street, 4 floor, New York, NY 10036 www.ansi.org ANSI 01.1 Safety Requirements for Woodworking Machines, and the U.S. Department of Labor regulations www.osha.gov

SAVE THESE INSTRUCTIONS!

SAFETY GUIDELINES - DEFINITIONS

It is important for you to read and understand this manual. The information it contains relates to protecting YOUR SAFETY and PREVENTING PROBLEMS. The symbols below are used to help you recognize this information.



▲ DANGER

indicates an imminently hazardous situation which, if not avoided, will result in death or serious injury.

▲ WARNING

indicates a potentially hazardous situation which, if not avoided, could result in death or serious injury.

▲ CAUTION

indicates a potentially hazardous situation which, if not avoided, may result in minor or moderate injury.

CAUTION

used without the safety alert symbol indicates a potentially hazardous situation which, if not avoided, may result in property damage.

CALIFORNIA PROPOSITION 65

▲ WARNING

Some dust created by power sanding, sawing, grinding, drilling, and other construction activities contains chemicals known (to the State of California) to cause cancer, birth defects or other reproductive harm. Some examples of these chemicals are:

- lead from lead-based paints
- crystalline silica from bricks and cement and other masonry products
- arsenic and chromium from chemically-treated lumber

Your risk from these exposures varies, depending on how often you do this type of work. To reduce your exposure to these chemicals: work in a well ventilated area, and work with approved safety equipment, always wear NIOSH/OSHA approved, properly fitting face mask or respirator when using such tools.

GENERAL SAFETY RULES

▲ WARNING Read all instructions. Failure to follow all instructions listed below may result in electric shock, fire and/or serious injury. The term "power tool" in all of the warnings listed below refers to your mains-operated (corded) power tool or battery-operated (cordless) power tool.



SAVE THESE INSTRUCTIONS

1) Work area safety

- a) **Keep work area clean and well lit.** Cluttered or dark areas invite accidents.
- b) **Do not operate power tools in explosive atmospheres, such as in the presence of flammable liquids, gases or dust.** Power tools create sparks which may ignite the dust or fumes.
- c) **Keep children and bystanders away while operating a power tool.** Distractions can cause you to lose control.

2) Electrical safety

- a) **Power tool plugs must match the outlet. Never modify the plug in any way. Do not use any adapter plugs with earthed (grounded) power tools.** Unmodified plugs and matching outlets will reduce risk of electric shock.
- b) **Avoid body contact with earthed or grounded surfaces such as pipes, radiators, ranges and refrigerators.** There is an increased risk of electric shock if your body is earthed or grounded.
- c) **Do not expose power tools to rain or wet conditions.** Water entering a power tool will increase the risk of electric shock.
- d) **Do not abuse the cord. Never use the cord for carrying, pulling or unplugging the power tool. Keep cord away from heat, oil, sharp edges or moving parts.** Damaged or entangled cords increase the risk of electric shock.
- e) **When operating a power tool outdoors, use an extension cord suitable for outdoor use.** Use of a cord suitable for outdoor use reduces the risk of electric shock.

3) Personal safety

- a) **Stay alert, watch what you are doing and use common sense when operating a power tool. Do not use a power tool while you are tired or under the influence of drugs, alcohol or medication.** A moment of inattention while operating power tools may result in serious personal injury.
- b) **Use safety equipment. Always wear eye protection.** Safety equipment such as dust mask, non-skid safety shoes, hard hat, or hearing protection used for appropriate conditions will reduce personal injuries.
- c) **Avoid accidental starting. Ensure the switch is in the off-position before plugging in.** Carrying power tools with your finger on the switch or plugging in power tools that have the switch on invites accidents.

GENERAL SAFETY RULES continued

- d) **Remove any adjusting key or wrench before turning the power tool on.** A wrench or a key left attached to a rotating part of the power tool may result in personal injury.
- e) **Do not overreach. Keep proper footing and balance at all times.** This enables better control of the power tool in unexpected situations.
- f) **Dress properly. Do not wear loose clothing or jewelry. Keep your hair, clothing and gloves away from moving parts.** Loose clothes, jewelry or long hair can be caught in moving parts.
- g) **If devices are provided for the connection of dust extraction and collection facilities, ensure these are connected and properly used.** Use of these devices can reduce dust-related hazards.

4) Power tool use and care

- a) **Do not force the power tool. Use the correct power tool for your application.** The correct power tool will do the job better and safer at the rate for which it was designed.
- b) **Do not use the power tool if the switch does not turn it on and off.** Any power tool that cannot be controlled with the switch is dangerous and must be repaired.
- c) **Disconnect the plug from the power source before making any adjustments, changing accessories, or storing power tools.** Such preventive safety measures reduce the risk of starting the power tool accidentally.
- d) **Store idle power tools out of the reach of children and do not allow persons unfamiliar with the power tool or these instructions to operate the power tool.** Power tools are dangerous in the hands of untrained users.
- e) **Maintain power tools. Check for misalignment or binding of moving parts, breakage of parts and any other condition that may affect the power tools operation. If damaged, have the power tool repaired before use.** Many accidents are caused by poorly maintained power tools.
- f) **Keep cutting tools sharp and clean.** Properly maintained cutting tools with sharp cutting edges are less likely to bind and are easier to control.
- g) **Use the power tool, accessories and tool bits etc., in accordance with these instructions and in the manner intended for the particular type of power tool, taking into account the working conditions and the work to be performed.** Use of the power tool for operations different from those intended could result in a hazardous situation.











5) Service

- a) **Have your power tool serviced by a qualified repair person using only identical replacement parts.** This will ensure that the safety of the power tool is maintained.

ADDITIONAL SPECIFIC SAFETY RULES

1. **Hold power tools by insulated gripping surfaces when performing an operation where the cutting tool may contact hidden wiring or its own cord.** Contact with a "live" wire will make exposed metal parts of the tool "live" and shock the operator.
2. **Wait for the cutter to stop before setting the tool down.** An exposed cutter may engage the surface leading to possible loss of control and serious injury.
3. **Use clamps or other practical way to secure and support the workpiece to a stable platform.** Holding the work by hand or against your body is unstable and may lead to loss of control.
4. **Keep blades sharp.** Sharp blades will do the job better and safer.
5. **When you have finished a cut** be careful not to come into contact with the blade. Turn off the motor immediately.
6. **Never hold work** in your hand, lap, or against other parts of your body.
7. **Keep guards in working order.** Check operation before each use. Do not use if guard does not close briskly over blade.
CAUTION If tool is dropped, guard may distort restricting operation. Keep slide mechanism free of wood chips. Occasionally lubricate with light tool oil. DO NOT OVER LUBRICATE as this creates excessive sawdust buildup.
8. **⚠ DANGER** **Keep hands away from cutting area.** Keep hands away from blade. Do not reach underneath work while blade is rotating.
9. **Avoid cutting nails and knots.** Inspect for and remove all nails from lumber before cutting. Try to layout cuts between knots.
10. **Wear eye and hearing protection. Always use safety glasses.** Everyday eyeglasses are NOT safety glasses. USE CERTIFIED SAFETY EQUIPMENT. Eye protection equipment should comply with ANSI Z87.1 standards. Hearing equipment should comply with ANSI S3.19 standards.
11. **⚠ WARNING** **Use of this tool can generate and disburse dust or other airborne particles, including wood dust, crystalline silica dust and asbestos dust.** Direct particles away from face and body. Always operate tool in well ventilated area and provide for proper dust removal. Use dust collection system wherever possible. Exposure to the dust may cause serious and permanent respiratory or other injury, including silicosis (a serious lung disease), cancer, and death. Avoid breathing the dust, and avoid prolonged contact with dust. Allowing dust to get into your mouth or eyes, or lay on your skin may promote absorption of harmful material. Always use properly fitting NIOSH/OSHA approved respiratory protection appropriate for the dust exposure, and wash exposed areas with soap and water.

SAVE THESE INSTRUCTIONS!

SYMBOL	DEFINITION
V	volts
A	amperes
Hz	hertz
W	watts
kW	kilowatts
F	farads
μ F	microfarads
l	litres
g	grams
kg	kilograms
bar	bars
Pa	pascals
h	hours
min	minutes
s	seconds
n_0	no-load speed
.../min or ...min ⁻¹	Revolutions or reciprocations per minute
 or d.c.	direct current
 or a.c.	alternating current
2 	two-phase alternating current
2N 	two-phase alternating current with neutral
3 	three-phase alternating current
3N 	three-phase alternating current with neutral
 A	rated current of the appropriate fuse-link in amperes
	time-lag miniature fuse-link where X is the symbol for the time/current characteristic, as given in IEC 60127
	protective earth
	class II tool
IPXX	IP symbol

SAVE THESE INSTRUCTIONS!

MOTOR

Many Porter-Cable tools will operate on either D.C., or single phase 25 to 60 cycle A.C. current and voltage within plus or minus 5 percent of that shown on the specification plate on the tool. Several models, however, are designed for A.C. current only. Refer to the specification plate on your tool for proper voltage and current rating.

CAUTION

Do not operate your tool on a current on which the voltage is not within correct limits. Do not operate tools rated A.C. only on D.C. current. To do so may seriously damage the tool.

EXTENSION CORD SELECTION

If an extension cord is used, make sure the conductor size is large enough to prevent excessive voltage drop which will cause loss of power and possible motor damage. A table of recommended extension cord sizes will be found in this section. This table is based on limiting line voltage drop to 5 volts (10 volts for 230 volts) at 150% of rated amperes.

If an extension cord is to be used outdoors, it must be marked with the suffix W-A or W following the cord type designation. For example – SJTW-A to indicate it is acceptable for outdoor use.

RECOMMENDED EXTENSION CORD SIZES FOR USE WITH PORTABLE ELECTRIC TOOLS

		Length of Cord in Feet									
		115V	25 Ft.	50 Ft.	100 Ft.	150 Ft.	200 Ft.	250 Ft.	300 Ft.	400 Ft.	500 Ft.
		230V	50 Ft.	100 Ft.	200 Ft.	300 Ft.	400 Ft.	500 Ft.	600 Ft.	800 Ft.	1000 Ft.
Nameplate Ampere Rating	0-2	18	18	18	16	16	14	14	12	12	
	2-3	18	18	16	14	14	12	12	10	10	
	3-4	18	18	16	14	12	12	10	10	8	
	4-5	18	18	14	12	12	10	10	8	8	
	5-6	18	16	14	12	10	10	8	8	6	
	6-8	18	16	12	10	10	8	6	6	6	
	8-10	18	14	12	10	8	8	6	6	4	
	10-12	16	14	10	8	8	6	6	4	4	
	12-14	16	12	10	8	6	6	6	4	2	
	14-16	16	12	10	8	6	6	4	4	2	
	16-18	14	12	8	8	6	4	4	2	2	
18-20	14	12	8	6	6	4	4	2	2		

SAVE THESE INSTRUCTIONS!

CARTON CONTENTS

- 1) Plate Joiner
- 2) Dust Bag
- 3) Carrying Case
- 4) Instruction Manual
- 5) Replacement Parts List
- 6) Combination Package

FUNCTIONAL DESCRIPTION

FOREWORD

Model 557 is designed to cut the grooves required for Porter-Cable biscuit sizes “FF”, “0”, “10”, and “20”. Adjustments are also provided which allow the tool to cut grooves for the following plate joiner accessories sold by other manufacturers: #6 biscuits, Duplex accessories, and Simplex accessories.

ASSEMBLY

NOTE: This tool is shipped completely assembled. No assembly time or tools are required.

SELECTING THE BISCUIT

Biscuits are $\frac{5}{32}$ " thick. They are available from Porter-Cable in four sizes as shown below. Choose the largest biscuit that will accommodate the type of joint being made.

BISCUITS Shown Actual Size

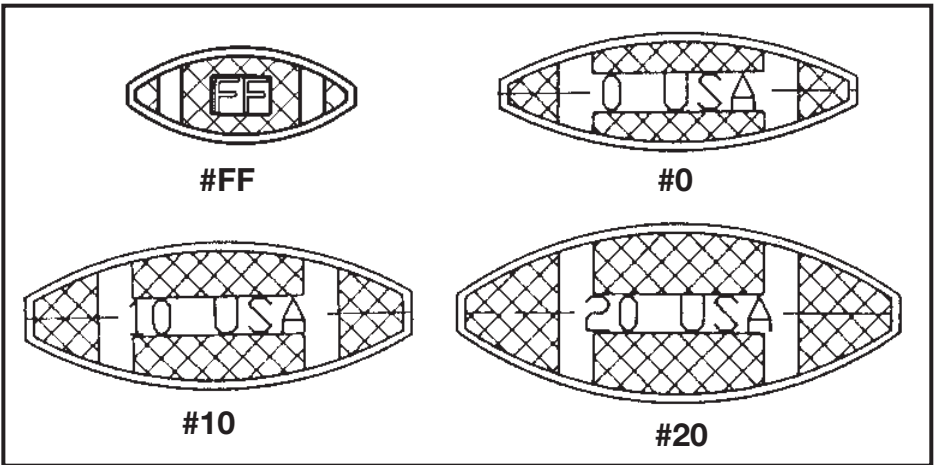

OPERATION

TO START AND STOP TOOL

⚠ WARNING Make sure switch is OFF and power circuit voltage is the same as that shown on the specification plate.

1. Connect tool to power circuit.
2. Grip tool firmly to resist starting torque, and squeeze trigger switch (A) Fig. 1, to START tool.
3. Release trigger switch to STOP tool.
4. Switch Lock: the trigger switch may be locked in the “ON” position as follows:
 - Squeeze trigger switch to START motor and depress lock button (B) Fig. 1, while releasing trigger switch. Release lock button.
 - To STOP tool: squeeze trigger switch and release, while leaving lock button free to spring out.

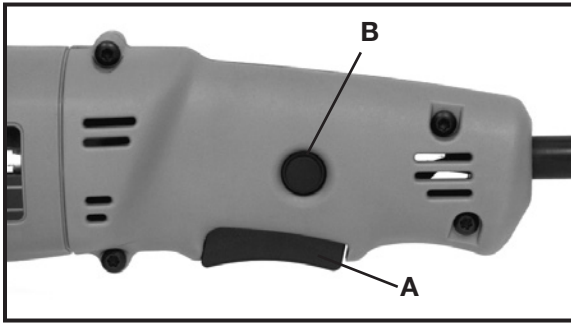

Fig. 1

ADJUSTING DEPTH OF GROOVE

A “quick set” depth adjusting turret (A) Fig. 2, provides for quick changes in depth of cut to accommodate the various sizes of available biscuits and other accessories. To set depth of cut: rotate depth adjusting turret until desired size marking on turret aligns with the index mark (B) Fig. 2. The following depth settings are provided:

- 0 For “0” size accessories
- 10 For “10” size accessories
- 20 For “20” size accessories
- MAX** For “6” size accessories, provides maximum depth of cut with 4" blade
- FF** For Porter-Cable “FF” biscuits
- D** For “Duplex” accessories
- S** For “Simplex” accessories

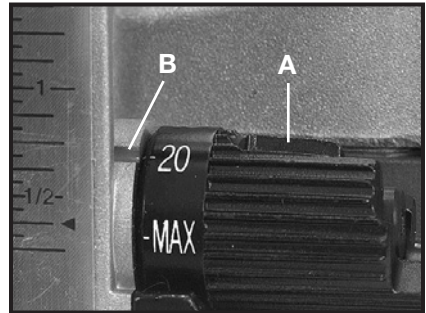

Fig. 2

FINE ADJUSTMENT (Depth of Groove)

The “quick set” depth adjustment is adjusted at the factory to produce joints with nominal clearance (biscuit to groove). A fine adjustment is provided allowing the operator to reduce or increase the clearance as desired. Adjust as follows:

1. Use an $\frac{7}{16}$ " wrench to loosen lock-nut (A) Fig. 3.
2. Rotate fine adjustment knob (B) Fig. 3, to desired position (rotate knob clockwise to reduce depth of cut, rotate knob counterclockwise to increase depth of cut).

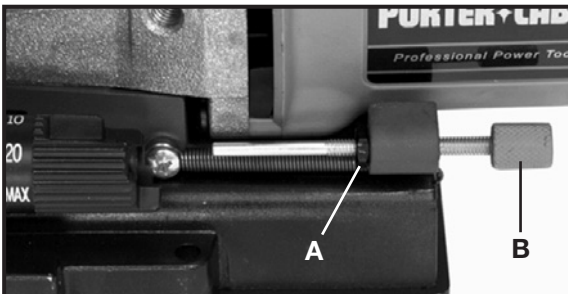

Fig. 3

3. While holding adjustment knob in desired position: tighten lock-nut firmly.

ADJUSTABLE FENCE

Model 557 is equipped with an integral, adjustable fence which:

- Provides micro height adjustment, distance scale includes indexes to top of cut, to center of cut, and to bottom of cut.
- Tilts 0° through 135°, with an adjustable stop at 90°.
- Does not have to be removed to make “flush” cuts.

Height Adjustment (see Figs. 4 & 5)

1. Loosen locking knob (A), and rotate knob (B) to position the fence as desired, (rotate knob clockwise to raise fence, rotate knob counterclockwise to lower fence).
2. The depth scale (C), indicates the distance from the top edge of the workpiece to the blade: **NOTE:** The bottom line on scale (C) begins at $\frac{1}{4}$ " and all lines are in $\frac{1}{16}$ " increments.
 - The line across the center of the index block (D), indicates the distance to the center of the blade.
 - The top edge of the index block (D), indicates the distance to the bottom of the blade.
 - The bottom edge of the index block (D), indicates the distance to the top of the blade.
 - The width of the index block (D), is equal to the thickness of the blade.
3. Once fence is in desired position, tighten knob (A), to secure in place.

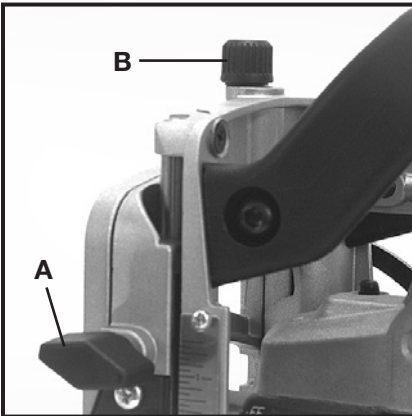

Fig. 4

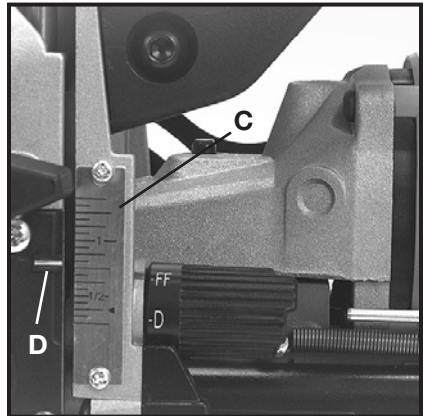

Fig. 5

Angle Adjustment (see Figs. 6, 7, 8 & 9)

1. Loosen locking knob (A).
2. For angles between 0° and 90°: swing fence downward until desired angle on lower scale (B), aligns with lower index mark (E). Tighten knob (A), to secure in place.
3. For angles between 90° and 135°: swing fence downward until the “gate” between the upper scale (D), and lower scale (B), aligns with locking knob. Swing scale arm down to align knob with upper scale. Move fence until desired angle on upper scale (D), aligns with upper index mark (C). Tighten knob (A), to secure in place.

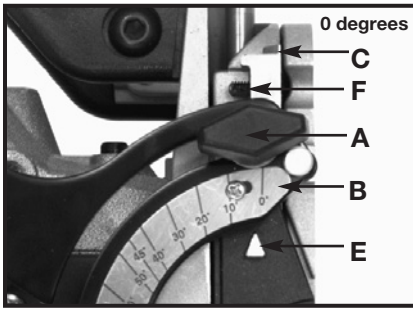

Fig. 6

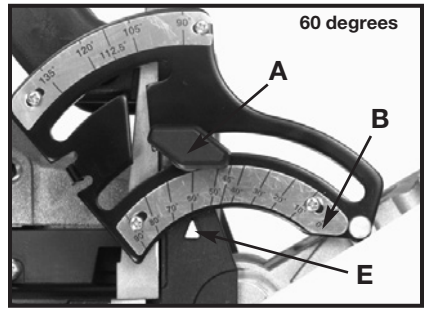

Fig. 7

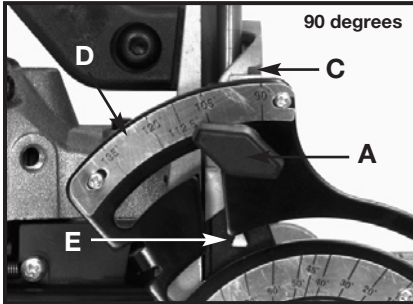

Fig. 8

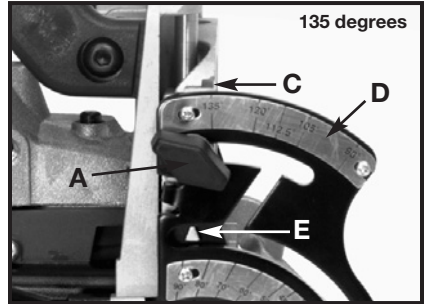

Fig. 9

FINE ADJUSTMENT (90° Position)

The adjustable 90° stop is factory adjusted for 90° and should not require additional adjustment. If “fine tuning” of the stop position is required: use a $\frac{5}{64}$ " hex wrench (not furnished), to rotate set-screw (F) Fig. 6, as required. Rotate the set-screw clockwise to reduce the angle of the fence, rotate the set-screw counterclockwise to increase the angle of the fence.

BLADES (2" and 4")

Model 557 is shipped with a 4" diameter blade installed. This blade is used for all operations except for the “FF” biscuit. The “FF” biscuit requires that the 2" blade (furnished with the tool), be installed as follows:

⚠ WARNING DISCONNECT TOOL FROM POWER SOURCE.

1. Loosen four blade cover retaining screws (A) Fig. 10, and remove blade cover.
2. Depress and hold spindle lock button (B) Fig. 11, while rotating blade by hand until spindle lock engages.
3. Continue to hold spindle lock button while using the $\frac{5}{32}$ " hex wrench (furnished with tool), to remove blade retaining bolt and flange, (by rotating counterclockwise).
4. Remove blade and store in a safe place for future use.
5. Place 2" diameter blade (furnished with tool), onto blade mounting flange (orient with teeth facing in same direction as directional arrow cast in housing, see Fig. 14).
6. Position blade retaining flange (flat side out), to spindle, insert blade bolt and rotate clockwise until hand-tight.
7. Depress and hold spindle lock button (B) Fig. 11, while rotating blade by hand until spindle lock engages.

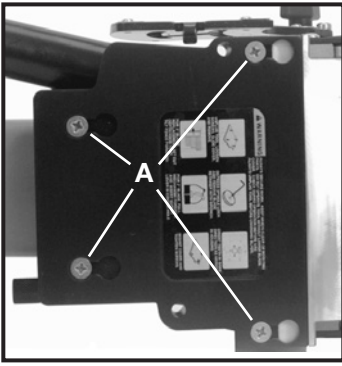

Fig. 10

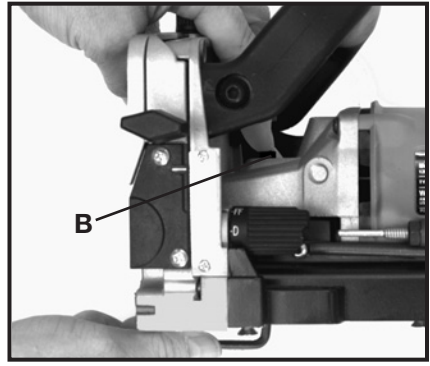

Fig. 11

8. Continue to hold spindle lock button while using the hex wrench (furnished with tool), to tighten blade retaining bolt securely, (by rotating clockwise).
9. Rotate the “quick set” depth adjusting turret (A) Fig. 12, to the “FF” position.
10. Lift safety lever (A) Fig. 13, fully retract the plunge mechanism, and reposition the safety lever as shown in Fig. 14. **Slowly** release pressure on plunge mechanism.
11. Reposition blade cover plate to tool, and secure in place with the four retaining screws (removed in step 1).

⚠ WARNING DO NOT OPERATE TOOL WITHOUT BLADE COVER INSTALLED.

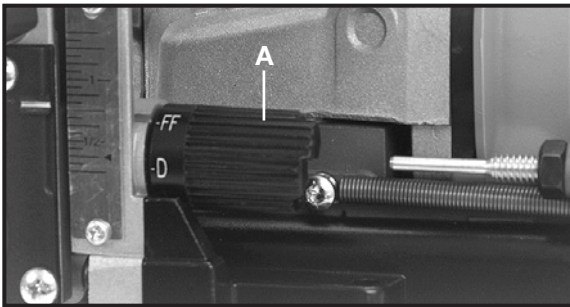

Fig. 12

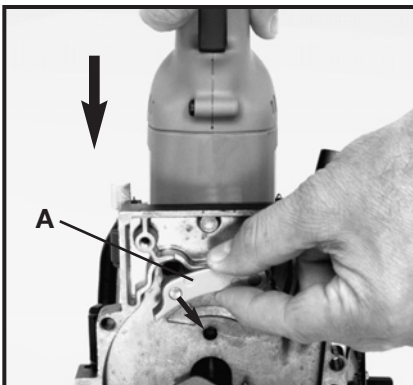

Fig. 13

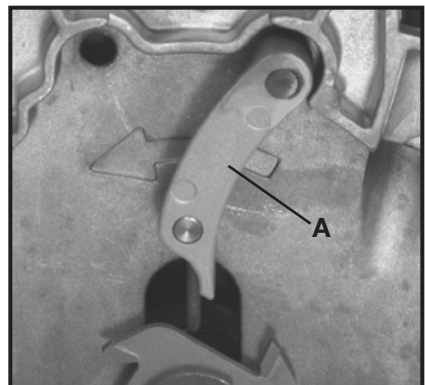

Fig. 14

ALIGNMENT PLATE (For Narrow Stock)

When joining narrow material, it will be necessary to install the alignment plate (A) Fig. 15, (furnished with tool). The alignment plate provides added support for narrow material, and has index marks to aid in centering the cut in the narrow material. Index marks are provided for 1½" wide, and 2" wide material. Install alignment plate as follows:

⚠ WARNING DISCONNECT TOOL FROM POWER SOURCE.

1. Align alignment plate with fence (see Fig. 15).
2. Slide alignment plate onto fence until it is seated (see Fig. 16).

NOTE: When alignment plate is installed: increase tool depth setting by 5/32" (to allow for thickness of the alignment plate).

3. To remove alignment plate: lift lightly on the alignment plate and slide off fence.

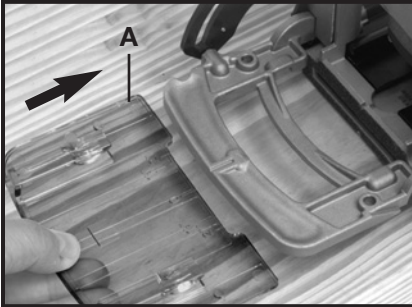

Fig. 15



Fig. 16

“DOUBLE” BISCUITS

The alignment plate may also be used as a spacer to produce a groove that is wide enough to accept two biscuits. After cutting a groove (or a group of grooves), in the normal fashion: install the alignment plate and repeat the cuts. This will double the width of each groove so that two biscuits can be installed in each groove.

DUST PORT

The tool is equipped with a dust port (A) Fig. 17. A large volume of sawdust and chips will be exhausted from this port during tool operation. A dust bag (B) Fig. 18 and a dust/chip deflector nozzle (C) Fig. 17 are furnished. A standard 1" vacuum hose can be connected to the dust port to facilitate dust collection.

⚠ CAUTION Do not operate the tool without a dust/chip deflector nozzle and dust bag, or a vacuum hose, attached to the dust port.



Fig. 17

Dust/Chip Deflector Nozzle

The dust/chip deflector nozzle (C) pushes onto the dust port (A) Fig. 17.

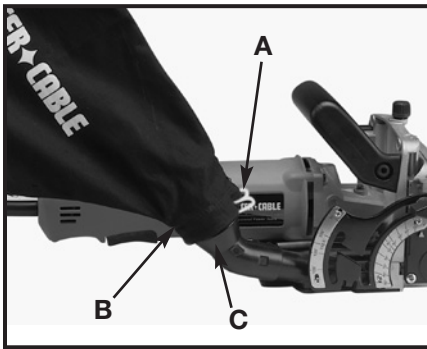

Fig. 18

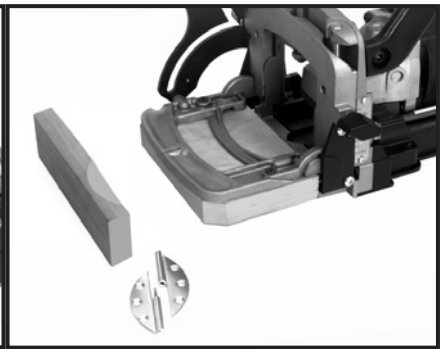

Fig. 18A

ATTACHING DUST BAG

Depress spring clips (A) Fig. 18, and clip dust bag (B) on end of dust/chip deflector (C). The bag is equipped with a zipper to ease emptying of the collected material.

Vacuum Hose

A standard 1" vacuum hose can be attached to the dust port to provide a means for connecting the tool to your vacuum cleaner or dust collection system.

“DUPLEX” HINGES

The 557 can be used to make the mortises required for installing “duplex” hinges. To accomplish this, you must make a spacer and attach it to the 557 fence. The spacer can be made of scrap $\frac{3}{4}$ " thick wood. Cut the spacer to approximately $3\frac{3}{8}$ " by $5\frac{1}{4}$ ", and attach it to the fence with two $\frac{3}{4}$ " long wood screws (see Fig. 18A).

#6 BISCUITS

With the 4" blade installed, set the depth adjusting turret to the MAX position. Two cuts will be required to produce each groove for a #6 biscuit. The **centerlines** of these two cuts should be spaced $\frac{1}{4}$ " apart. When laying-out these cuts, mark the first cut centerline, move over $\frac{1}{4}$ " and mark the second cut centerline.

POSITIONING GROOVES

The number of grooves (biscuits) used in a joint may be varied to provide the strength required for the particular application. Typically, the center of the first groove is positioned approximately two inches from the edge of the work with additional grooves spaced at three to six inches on centers.

In most cases, one line of grooves (biscuits) positioned approximately along the centerline of the material is used. On thicker material, an additional row(s) of biscuits may be used for added strength. The possibilities are almost endless.

Position the two workpieces (to be joined) in the relationship desired after joining. Mark the centerline of each groove required as shown in Fig. 19. Use a square to assure accuracy.

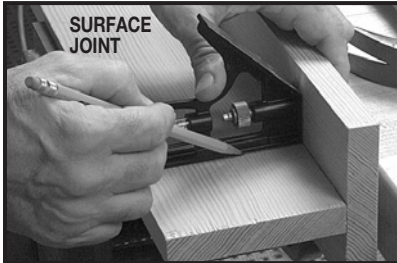

PRACTICE CUTS

After each set-up or adjustment to the tool, it is recommended you make several practice cuts in scrap material to verify desired operation.

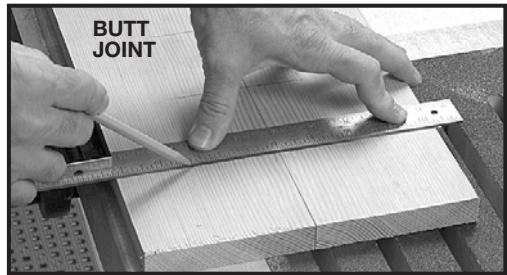

Fig. 19

CORNER JOINTS

1. Layout groove positions as described in **POSITIONING GROOVES.**
2. Set depth stop turret to desired biscuit (or other accessory), size.
3. Set the tilt fence to the 90° position (see **ANGLE ADJUSTMENT** Section of this manual).
4. Set fence height adjustment to desired height (usually $\frac{1}{2}$ the material thickness), (see **HEIGHT ADJUSTMENT** Section of this manual).
5. Clamp the workpiece securely.
6. Position tool to work-piece with bottom of fence resting on workpiece. Align guide notch (A) or (B) Fig. 20, with a groove centerline. Apply pressure to auxiliary handle (C) Fig. 20, to keep front of tool and fence in firm contact with workpiece.

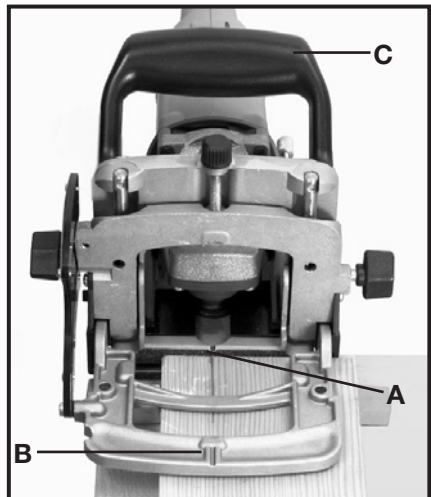

Fig. 20

7. Hold tool firmly as shown in Fig. 21, squeeze trigger switch to start tool.

8. At a slow, steady pace, push tool forward in base as far as depth stop allows.

9. Release trigger switch to stop tool and remove tool from work.

10. Repeat steps 6 through 9 until all the grooves for this joint are completed.



Fig. 21

NOTE: Assemble all joints and verify alignments before applying glue (see Fig. 22).

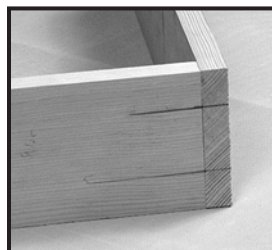
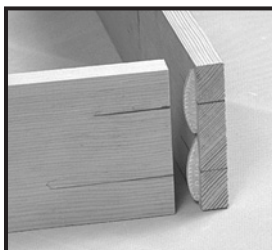
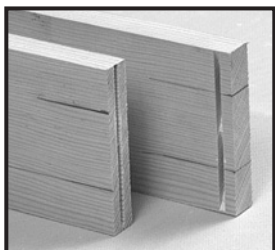

Fig. 22

SURFACE ("T") JOINTS

1. Layout groove positions as described in **POSITIONING GROOVES**.
2. Set depth stop turret to desired biscuit (or other accessory), size.
3. Mark centerline of joint on workpiece "A" (see Fig. 23).
4. Clamp a straight edge guide to the workpiece, $\frac{3}{8}$ " back from the joint centerline (as marked in Step 2). Clamp workpiece securely (see Fig. 24).
5. Set tilt fence to 0° position (see Angle Adjustment Section of this manual).
6. Position tool to workpiece with bottom of base against straight edge and guide notch (C) Fig. 25, aligned with a groove centerline. Apply pressure to auxiliary handle (D) Fig. 25 to hold tool firmly in place.
7. Hold tool firmly as shown in Fig. 21. Squeeze trigger switch to start tool.

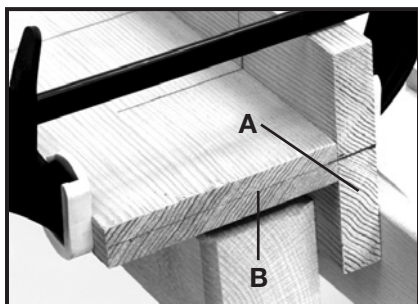

Fig. 23

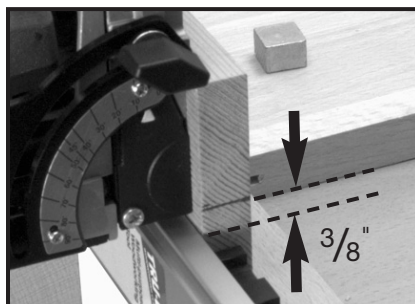

Fig. 24

8. At a slow, steady pace, push tool forward in base as far as depth stop allows.
9. Release trigger switch to stop tool and remove tool from work.
10. Repeat steps 5 through 8 until all the grooves in workpiece “A” are completed.
11. Follow steps 3 through 10 of **CORNER JOINTS** Section to complete required grooves in workpiece “B” Fig. 23.

NOTE: Assemble all joints and verify alignments before applying glue (see Fig. 26).

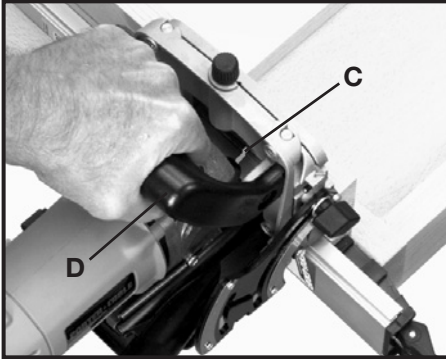

Fig. 25

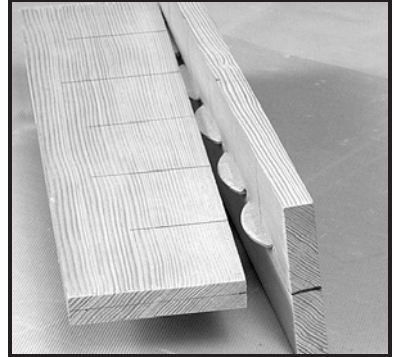

Fig. 26

BUTT JOINTS

Tool adjustment and operation for producing butt joints (see Fig. 19), is the same as for **CORNER JOINTS**.

MITER JOINTS

1. Layout groove positions as described in **POSITIONING GROOVES**.
2. Set depth stop turret to desired biscuit (or other accessory), size.
3. Set the tilt fence to desired angle (see Angle Adjustment Section of this manual).
4. Set fence height adjustment to desired height (see Height Adjustment Section of this manual).
5. Clamp workpiece securely.
6. Position tool to workpiece utilizing either guide notch (A) or (B) Fig. 27, to align tool with a groove centerline.

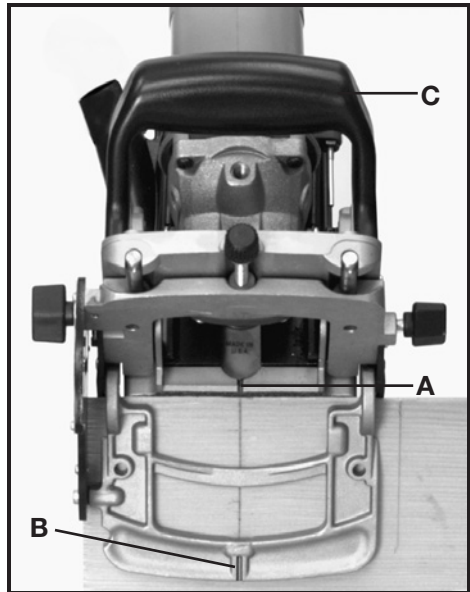

Fig. 27

Apply pressure to auxiliary handle (C) Fig. 27, to hold tool firmly in place.

7. Hold tool firmly as shown in Fig. 28, and squeeze trigger switch to start tool.
8. At a slow, steady pace, push tool forward in base as far as depth stop allows.
9. Release trigger switch to stop tool and remove tool from work.
10. Repeat Steps 5 through 8 until all the grooves for this joint are completed.

NOTE: Assemble all joints and verify alignments before applying glue (see Fig. 29).

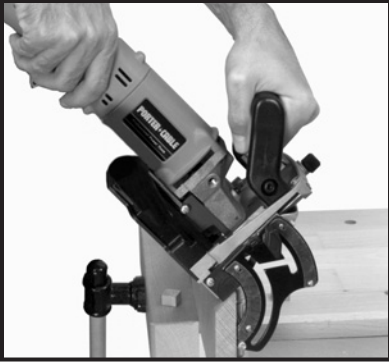

Fig. 28

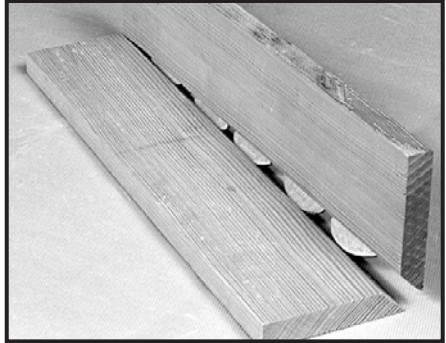

Fig. 29

TROUBLESHOOTING

For assistance with your tool, visit our website at www.porter-cable.com for a list of service centers or call the Porter-Cable help line at 1-800-487-8665.

MAINTENANCE

KEEP TOOL CLEAN

Periodically blow out all air passages with dry compressed air. All plastic parts should be cleaned with a soft damp cloth. NEVER use solvents to clean plastic parts. They could possibly dissolve or otherwise damage the material.

⚠️WARNING Wear ANSI Z87.1 safety glasses while using compressed air.

FAILURE TO START

Should your tool fail to start, check to make sure the prongs on the cord plug are making good contact in the outlet. Also, check for blown fuses or open circuit breakers in the line.

LUBRICATION

This tool has been lubricated with a sufficient amount of high grade lubricant for the life of the unit under normal operating conditions. No further lubrication is necessary.

BRUSH INSPECTION (If applicable)

For your continued safety and electrical protection, brush inspection and replacement on this tool should ONLY be performed by an AUTHORIZED PORTER-CABLE SERVICE STATION or a PORTER-CABLE•DELTA FACTORY SERVICE CENTER.

At approximately 100 hours of use, take or send your tool to your nearest authorized Porter-Cable Service Station to be thoroughly cleaned and inspected. Have worn parts replaced and lubricated with fresh lubricant. Have new brushes installed, and test the tool for performance.

Any loss of power before the above maintenance check may indicate the need for immediate servicing of your tool. DO NOT CONTINUE TO OPERATE TOOL UNDER THIS CONDITION. If proper operating voltage is present, return your tool to the service station for immediate service.

SERVICE

REPLACEMENT PARTS

When servicing use only identical replacement parts. For a service parts list or to learn more about Porter-Cable visit our website at www.porter-cable.com

SERVICE AND REPAIRS

All quality tools will eventually require servicing, or replacement of parts due to wear from normal use. For assistance with your tool, visit our website at www.porter-cable.com for a list of service centers or call the Customer Care Department at **1-800-487-8665**. All repairs made by our service centers are fully guaranteed against defective material and workmanship. We cannot guarantee repairs made or attempted by others.

Should you have any questions about your tool, feel free to write us at any time. In any communications, please give all information shown on the nameplate of your tool (model number, type, serial number, etc.).

ACCESSORIES

A complete line of accessories is available from your Porter-Cable•Delta Supplier, Porter-Cable•Delta Factory Service Centers, and Porter-Cable Authorized Service Stations. Please visit our Web Site www.porter-cable.com for a catalog or for the name of your nearest supplier.

▲ WARNING

Since accessories other than those offered by Porter-Cable•Delta have not been tested with this product, use of such accessories could be hazardous. For safest operation, only Porter-Cable•Delta recommended accessories should be used with this product.

WARRANTY

PORTER-CABLE LIMITED ONE YEAR WARRANTY

Porter-Cable warrants its Professional Power Tools for a period of one year from the date of original purchase. We will repair or replace at our option, any part or parts of the product and accessories covered under this warranty which, after examination, proves to be defective in workmanship or material during the warranty period. For repair or replacement return the complete tool or accessory, transportation prepaid, to your nearest Porter-Cable Service Center or Authorized Service Station. Proof of purchase may be required. This warranty does not apply to repair or replacement required due to misuse, abuse, normal wear and tear or repairs attempted or made by other than our Service Centers or Authorized Service Stations.

ANY IMPLIED WARRANTY, INCLUDING THE IMPLIED WARRANTIES OF MERCHANTABILITY AND FITNESS FOR A PARTICULAR PURPOSE, WILL LAST ONLY FOR ONE (1) YEAR FROM THE DATE OF PURCHASE.

To obtain information on warranty performance please write to: PORTER-CABLE CORPORATION, 4825 Highway 45 North, Jackson, Tennessee 38305; Attention: Product Service. THE FOREGOING OBLIGATION IS PORTER-CABLE'S SOLE LIABILITY UNDER THIS OR ANY IMPLIED WARRANTY AND UNDER NO CIRCUMSTANCES SHALL PORTER-CABLE BE LIABLE FOR ANY INCIDENTAL OR CONSEQUENTIAL DAMAGES. Some states do not allow limitations on how long an implied warranty lasts or the exclusion or limitation of incidental or consequential damages, so the above limitation or exclusion may not apply to you.

This warranty gives you specific legal rights and you may also have other legal rights which vary from state to state.

PORTER-CABLE • DELTA SERVICE CENTERS (CENTROS DE SERVICIO DE PORTER-CABLE • DELTA) (CENTRE DE SERVICE PORTER-CABLE • DELTA)

**Parts and Repair Service for Porter-Cable • Delta Power Tools are Available at These Locations
(Obtenga Refacción de Partes o Servicio para su Herramienta en los Sigüientes Centros de Porter-Cable • Delta)
(Locations où vous trouverez les pièces de rechange nécessaires ainsi qu'un service d'entretien)**

ARIZONA

Phoenix 85013-2906
4501 N. 7th Ave.
Phone: (602) 279-6414
Fax: (602) 279-5470

CALIFORNIA

Ontario 91761 (Los Angeles)
3949A East Guasti Road
Phone: (909) 390-5555
Fax: (909) 390-5554

San Diego 92111
7290 Clairemont Mesa Blvd.
Phone: (858) 279-2011
Fax: (858) 279-0362

San Leandro 94577 (Oakland)
3039 Teagarden Street
Phone: (510) 357-9762
Fax: (510) 357-7939

COLORADO

Denver 80223
700 West Mississippi Ave.
Phone: (303) 922-8325
Fax: (303) 922-0245

FLORIDA

Davie 33314 (Miami)
4343 South State Rd. 7 (441)
Unit #107
Phone: (954) 321-6635
Fax: (954) 321-6638

Tampa 33634
4909 West Waters Ave.
Phone: (813) 884-0434
Fax: (813) 888-5997

GEORGIA

Forest Park 30297 (Atlanta)
5442 Frontage Road,
Suite 112
Phone: (404) 608-0006
Fax: (404) 608-1123

ILLINOIS

Addison 60101 (Chicago)
400 South Rohwing Rd.
Phone: (630) 424-8805
Fax: (630) 424-8895

Woodridge 60517 (Chicago)
2033 West 75th Street
Phone: (630) 910-9200
Fax: (630) 910-0360

KANSAS

Overland Park 66214
9201 Quivira Road
Phone: (913) 495-4330
Fax: (913) 495-4378

MARYLAND

Elkridge 21075 (Baltimore)
7397-102 Washington Blvd.
Phone: (410) 799-9394
Fax: (410) 799-9398

MASSACHUSETTS

Franklin 02038 (Boston)
Franklin Industrial Park
101E Constitution Blvd.
Phone: (508) 520-8802
Fax: (508) 528-8089

MICHIGAN

Madison Heights 48071 (Detroit)
30475 Stephenson Highway
Phone: (248) 597-5000
Fax: (248) 597-5004

MINNESOTA

Eden Prairie 55344
9709 Valley View Road
Phone: (952) 884-9191
Fax: (952) 884-3750

MISSOURI

St. Louis 63146
11477 Page Service Drive
Phone: (314) 997-9100
Fax: (314) 997-9183

NEW YORK

Flushing 11365-1595 (N.Y.C.)
175-25 Horace Harding Expwy.
Phone: (718) 225-2040
Fax: (718) 423-9619

NORTH CAROLINA

Charlotte 28270
9129 Monroe Road, Suite 115
Phone: (704) 841-1176
Fax: (704) 708-6265

OHIO

Columbus 43229
1948 Schrock Road
Phone: (614) 895-3112
Fax: (614) 895-3187

Cleveland 44125
8001 Sweet Valley Drive Unit #19
Phone: (216) 447-9030
Fax: (216) 447-3097

OREGON

Portland 97230
14811 North East Airport Way
Phone: (503) 255-6556
Fax: (503) 255-6543

PENNSYLVANIA

Willow Grove 19090 (Philadelphia)
520 North York Road
Phone: (215) 658-1430
Fax: (215) 658-1433

TEXAS

Carrollton 75006 (Dallas)
1300 Interstate 35 N, Suite 112
Phone: (972) 446-2996
Fax: (972) 446-8157

Houston 77022-2122

536 East Tidwell Rd.
Phone: (713) 692-7111
Fax: (713) 692-1107

WASHINGTON

Auburn 98001 (Seattle)
3320 West Valley HWY, North
Building D, Suite 111
Phone: (253) 333-8353
Fax: (253) 333-9613

Authorized Service Stations are located in many large cities. Telephone **800-487-8665** or **731-541-6042** for assistance locating one. Parts and accessories for Porter-Cable • Delta products should be obtained by contacting any Porter-Cable • Delta Distributor, Authorized Service Center, or Porter-Cable • Delta Factory Service Center. If you do not have access to any of these, call **888-848-5175** and you will be directed to the nearest Porter-Cable • Delta Factory Service Center. Las Estaciones de Servicio Autorizadas están ubicadas en muchas grandes ciudades. Llame al **800-487-8665** o al **731-541-6042** para obtener asistencia a fin de localizar una. Las piezas y los accesorios para los productos Porter-Cable • Delta deben obtenerse poniéndose en contacto con cualquier distribuidor Porter-Cable • Delta, Centro de Servicio Autorizado o Centro de Servicio de Fábrica Porter-Cable • Delta. Si no tiene acceso a ninguna de estas opciones, llame al **888-848-5175** y le dirijirán al Centro de Servicio de Fábrica Porter-Cable • Delta más cercano. Des centres de service agréés sont situés dans beaucoup de grandes villes. Appelez au **800-487-8665** ou au **731-541-6042** pour obtenir de l'aide pour en repérer un. Pour obtenir des pièces et accessoires pour les produits Porter-Cable • Delta, s'adresser à tout distributeur Porter-Cable • Delta, centre de service agréé ou centre de service d'usine Porter-Cable • Delta. Si vous n'avez accès à aucun de ces centres, appeler le **888-848-5175** et on vous dirigera vers le centre de service d'usine Porter-Cable • Delta le plus proche.

CANADIAN PORTER-CABLE • DELTA SERVICE CENTERS

ALBERTA

Bay 6, 2520-23rd St. N.E.
Calgary, Alberta
T2E 8L2
Phone: (403) 735-6166
Fax: (403) 735-6144

BRITISH COLUMBIA

8520 Baxter Place
Burnaby, B.C.
V5A 4T8
Phone: (604) 420-0102
Fax: (604) 420-3522

MANITOBA

1699 Dublin Avenue
Winnipeg, Manitoba
R3H 0H2
Phone: (204) 633-9259
Fax: (204) 632-1976

ONTARIO

505 Southgate Drive
Guelph, Ontario
N1H 6M7
Phone: (519) 767-4132
Fax: (519) 767-4131

QUÉBEC

1515 Ave.
St-Jean Baptiste, Suite 160
Québec, P.Q.
G2E 5E2
Phone: (418) 877-7112
Fax: (418) 877-7123

1447, Begin
St-Laurent, (Mt), P.Q.
H4R 1V8
Phone: (514) 336-8772
Fax: (514) 336-3505

The following are trademarks of PORTER-CABLE • DELTA (Las siguientes son marcas registradas de PORTER-CABLE • DELTA S.A.) (Les marques suivantes sont des marques de fabricant de la PORTER-CABLE • DELTA): Auto-Set®, BAMMER®, B.O.S.S.®, Builder's Saw®, Contractor's Saw®, Contractor's Saw II™, Delta®, DELTACRAFT®, DELTAGRAM™, Delta Series 2000™, DURATRONIC™, Emc2™, FLEX®, Flying Chips™, FRAME SAW™, Grip Vac™, Homecraft®, INNOVATION THAT WORKS®, Jet-Lock®, JETSTREAM®, 'kickstand', LASERLOC®, MICRO-SET™, Micro-Set®, MIDI LATHÉ®, MORE™, NETWORK™, OMNIJIG®, POCKET CUTTER®, PORTA-BAND®, PORTA-PLANE®, PORTER-CABLE®&(design), PORTER-CABLE®PROFESSIONAL POWER TOOLS, PORTER-CABLE REDEFINING PERFORMANCE™, Posi-Matic®, Q-3®&(design), QUICKSAND®&(design), QUICKSET™, QUICKSET II®, QUICKSET PLUS™, RIPTIDE™&(design), SAFE GUARD II®, SAFE-LOC®, Sanding Center®, SANDTRAP®&(design), SAW BOSS™, Sawbuck™, Sidekick®, SPEED-BLOC®, SPEEDMATIC®, SPEEDTRONIC®, STAIR EASE™, The American Woodshop®&(design), The Lumber Company®&(design), THE PROFESSIONAL EDGE™, THE PROFESSIONAL SELECT®, THIN-LINE™, TIGER®, TIGER CUB®, TIGER SAW™, TORQBUSTER®, TORQ-BUSTER®, TORQ-MATCH™, TWIN-LITE™, UNIGUARD®, Unifencer®, UNIFEEDER™, Unihead®, Uniplane™, Unirip®, Unisaw®, Univise®, Versa-Feeder®, VERSA-PLANE®, WHISPER SERIES®, WOODWORKER'S CHOICE™.

Trademarks noted with ™ and ® are registered in the United States Patent and Trademark Office and may also be registered in other countries. Las Marcas Registradas con el signo de ™ y ® son registradas por la Oficina de Registros y Patentes de los Estados Unidos y también pueden estar registradas en otros países. Marques déposées, indiquées par la lettre ™ et ®, sont déposées au Bureau des brevets d'invention et marques déposées aux Etats-Unis et pourraient être déposées aux autres pays.